

**Ponndorf**

# **Hose Pump Series**

***P\_classic twin / PC-T***

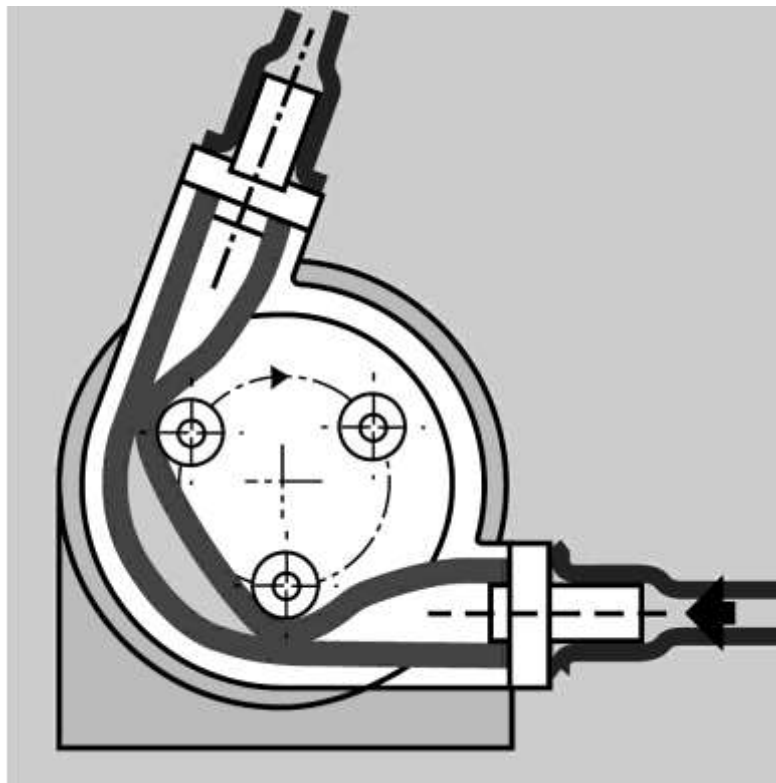

# **Operation Manual**



---

## Content

<b>2. General</b> .....	3
2.1 Service address .....	3
2.2 General information .....	3
2.3 Labelling .....	4
2.4 Guarantee.....	5
2.5 Technical data .....	5
<b>3. Safety</b> .....	6
3.1 Marking of details in the operation manual .....	6
3.2 Safety instructions for hose pumps in hazardous locations .....	7
3.3 Intended use .....	7
3.4 Qualification and training of personnel.....	8
3.5 Dangers in case of non-observance of the safety instructions.....	8
3.6 Safety-conscious working .....	9
3.7 Safety instructions for the operator/user .....	9
3.8 Safety instructions for maintenance / inspection / assembly.....	9
3.9 Unauthorized modifications or use of unoriginal parts .....	10
3.10 Unauthorized operating methods .....	10
<b>4. Transport, storage and disposal</b> .....	11
4.1 Transport .....	11
4.2 Storage .....	11
4.3 Disposal.....	11
<b>5. Description of pump and accessories</b> .....	12
5.1 Detector for hose leakages .....	13
5.2 Diagram of the leakage detector for operating the pumps in non-hazardous locations (Part no. 93-000-003) .....	14
5.3 Diagram of the leakage detector for operating the pumps in hazardous locations (Part no.93-000-006) .....	15

---

<b>6. Installation / Connection / Operation</b> .....	16
6.1 Installation of pumps in hazardous locations .....	16
6.2 Electrical connection .....	17
6.3 Mechanical connection .....	17
6.4 Installing the pump hoses .....	20
<b>7. Maintenance / Service</b> .....	23
7.1 Changing the pump hose.....	23
7.2 Maintenance / Service .....	24
7.3 Cleaning.....	24
7.4 Drawing of spare parts P_classic 10 twin / PC_10-T .....	25
7.5 List of spare parts P_classic 10 twin / PC_10-T.....	26
7.6 Drawing of spare parts P_classic 15-50 twin / PC_15-T to PC_50-T.....	27
7.7 List of spare parts P_classic 15-50 twin / PC_15-T to PC_50-T .....	28
<b>8. Characteristic curves</b> .....	29
<b>9. Accompanying documents</b> .....	31

---

## 2. General

### 2.1 Service address

PONNDORF GERÄTETECHNIK GmbH  
Leipziger Strasse 374  
D - 34123 Kassel  
Tel. +49 561 51139 - 0  
Fax: +49 561 51139 - 88  
E-Mail: [service@ponndorf.de](mailto:service@ponndorf.de)

### 2.2 General information

Ponndorf Hose Pumps are a self-priming positive displacement pumps without any glands or valves. The pumping medium only comes in contact the inner surface of the pump hose, but not with the moving parts of the pump. Therefore the pumps are particularly suitable for pumping aggressive, abrasive and viscous liquids, but as well for pumping liquids containing coarse-grained solids and sensitive materials which require to be pumped gently.



Priming and pumping of combustible gases or fumes is prohibited. Start-up and shutdown processes which require this should only be rarely and kept as short as possible. Dry running of the pump (operation without the pumping media) must generally be avoided, apart from the start-up and shutdown processes mentioned before.



The operator must ensure that the relevant safety regulations (e.g. TRGS 727) for the pumped medium are observed to avoid dangerous electrostatic charging. Among other things, please consider flow velocities, etc.



Hose pumps are only intended to pump free-flowing liquids but not to pump gaseous pumping media.



The functioning of a hose pump can lead to abrasion on the pump hose. For applications in which the possible abrasion is intermittent or not permissible, appropriate filter technology must be provided by the customer.



To guarantee the tightness and chemical compatibility of the pump hoses, the manufacturer of the hose pump must be consulted in case of possible changes of the pumping media unless this information does not appear from available documents.



To avoid blockages of the pumps and/or any other damages of pumps or pump hoses, the operator must guarantee that no hose damaging objects can invade the hoses (e.g. sharp-edged or too big and not pumpable objects). A suitable strainer may be used as protection.

## 2.3 Labelling



1. Pump Type <sup>1)</sup>
2. Maximum Pressure
3. Pump Number and Year of Manufacture
4. ATEX Coding (optional)
5. Ambient Temperature Limit in EX-Zone (optional)
6. Customer Number – Order Number Ponndorf

- 1) Explanations of pump type: PC-T corresponds to series P\_classic twin  
Example: PC\_50-T = P\_classic 50 twin

The data specified on the name plate refer to the delivery status of the Ponndorf Hose Pump. Any modification of the pump can result in a change of the specified data and the request of a new name plate for the Ponndorf Hose Pump could be necessary.

When requesting spares, the model and serial number should always be quoted.

## 2.4 Guarantee

The guarantee for defects of any goods delivered by us is stated in our Terms and Conditions of Sale.

We do not assume any liability for defects and damages which are caused by non-observance of the instructions of the operation manual.

Furthermore we assume no liability for defects or damages which are caused by changing the operating conditions (use not in accordance with the intended use), e.g. use of a different pumping medium for which the pump hose is not suitable for, higher temperature which exceed the maximum permissible or line losses caused by media with a too high viscosity.

## 2.5 Technical data

Series	Size	P_classic twin / PC-T				
		10	15	27	35	50
Max. flow rate:	[l/h H <sub>2</sub> O]	250	950	5.000	11.500	24.500
Max. pressure:	[bar]	2				
Max. suction height:	[m H <sub>2</sub> O]	7				
Max. viscosity of pumping media:	[mPas]	35.000				
Max. motor power:	[kW]	0,37	0,55	1,1	3	4
Max. speed:	[n/min]	165				
Weight: execution XXX execution GMC execution BDC	[kg]	7,5 34,8 39,8	13,0 45,8 54,8	27,0 67,2 76,2	50,0 116,4 max. 136,4	82,0 max. 169,9 189,9
Hose material:		Natural rubber, Neoprene, Natural rubber according to 21 CFR of FDA				

### 3. Safety

These instructions contain basic recommendations that should be followed during installation, operation and maintenance. Therefore the operation manual has to be read by the fitter and qualified personnel/operator before installation and operation and must always be available at the location of the machine/facility.

Not only the general instructions of safety mentioned in chapter - Safety - have to be observed. The more specific safety instructions mentioned in other chapters must be observed, too.

#### 3.1 Marking of details in the operation manual

Non-observance of the safety instructions of this operation manual can endanger people. Those instructions are particularly marked with the following general danger signs:



Safety sign according to DIN 4844 - W 9



Safety sign according to DIN 4844 - W 8  
when warning of electrical hazards



Product-specific properties for explosion protection according to 2014/34 / EU are marked with the label in the operating instructions, e.g. the intended use, temperatures.



The symbol is used in the operating instructions to mark safety-related information relating to Directive 1999/92 / EC (ATEX operating directive) that must be observed when operating the pumps, e.g. maintenance information.



In case of safety instructions which can cause dangers for the machine or its performance the term **CAUTION** is interpolated.

Signs directly fixed to the machine, e.g.

- arrows which indicate the flow rotation
- signs for fluid connections

have to be observed and must be kept in a readable condition.



---

### 3.2 Safety instructions for hose pumps in hazardous locations



- Explosive gas mixture or dust concentration can cause serious or even fatal injuries in conjunction with hot, voltaged, pressurized and moved parts of the pump
- Only qualified technical personnel is authorized to effect installation, connection, operation as well as maintenance and repair works in consideration of
  - provided instructions
  - danger signs and/or decal information
  - every other provided instructions for the user
  - the system-dependent regulations and requirements
  - the currently valid regulations concerning explosion protection and safety as well as rules for accident prevention
- **The pump in connection with the mobile base plate only fulfils the ATEX directive (EC Directive 2014/34/EC) in a stationary condition.**

In case of moving the pump the operator has to make sure that no explosive environment exists!

### 3.3 Intended use



- Ponndorf Hose Pumps are intended for use in commercial facilities and are only permitted for use in accordance to the information of the technical documentation and of the nameplate. They comply to the currently valid standards and regulations and meet the requirements of the European directive 2014/34/EC.
- If a pump is coupled to a drive unit, the operating manual of the drive and other provided components must be observed, too.

---

**Before placing the pump into operation the operator must make sure that**



- the pump and all other components were not damaged during the carriage.
- the information on the nameplate concerning equipment group and category, zone, temperature class and explosion group accords with the permissible use in the particular hazardous location.
- the air temperature of the ambience of the pump is observed.
- the maximum temperature of the pumping media is not exceeded.
  - +60°C continuous operation
  - +80°C short-time operation (operating time max. 1 h)
- pump hose, clamping rings and connecting sockets are mounted properly and the pump hose is greased sufficiently with Ponndorf special grease (as described in chapter 6.4).

**In case of any discrepancies the pump must not be placed into operation!**

While placing the pump into operation the characteristics (pump speed, pressure) which are prescribed in the manual and on the nameplate must not be exceeded.

### **3.4 Qualification and training of personnel**

The technical personnel responsible for operation, maintenance, inspection and installation must be qualified for this work. Fields of responsibility, competencies and the supervision of the personnel have to be exactly regulated by the operator. If the personnel is inadequately skilled it must be trained and instructed. If necessary, this may be effected by order of the operator by the manufacturer/supplier. Furthermore the operator has to make sure that the personnel did absolutely catch the contents of the operation manual.

### **3.5 Dangers in case of non-observance of the safety instructions**

Non-observance of the safety instructions can endanger people, environment and equipment and can result in losing any claim for damages.

---

In detail non-observance can **for instance** result in the following dangers:

- failure of important functions of the machine/facility
- failure of methods prescribed for maintenance
- threat to people because of electrical, mechanical and chemical effects
- danger to the environment because of leakage of hazardous substances

### **3.6 Safety-conscious working**

The safety instructions of this manual, the existing national rules for accident prevention as well as potential instructions of the operator for work, operation and safety have to be observed.

### **3.7 Safety instructions for the operator/user**

- If hot or cold machine parts cause dangers, the operator is responsible for a protection against contact.
- The protection against contact of moving parts of machines in operation (e.g. coupling) must not be removed.
- Leakages of hazardous pumping media (e.g. explosive, toxic, hot) have to be discharged in a way which guarantees that no dangers to people and environment arise. Legal regulations have to be observed.
- Dangers caused by electrical power have to be eliminated.  
(Please see also regulations e.g. of the VDE (in Germany) or of the local power supply companies.)



### **3.8 Safety instructions for maintenance / inspection / assembly**

The operator has to make sure that all maintenance, inspection and installation works will be effected by authorized and qualified technical personnel, which is familiar with the contents of the operating manual.

Basically all works may only effected during shutdown periods. The proceeding to shutdown the machine described in the operating manual must be strictly observed.

Pumps or aggregates which convey harmful media have to be cleaned.

When works are finished all safety installations and protectors must immediately be refitted or be put into operation.

The articles of chapter 6 (Installation / Connection / Operation) have to be observed before reconnection.

### **3.9 Unauthorized modifications or use of unoriginal parts**

Modifications of the machine are only permissible after prior consultation of the manufacturer. Original spare parts and accessories authorized by the manufacturer serve the safety. Use of other parts can repeal the liability for any consequences.

### **3.10 Unauthorized operating methods**

The reliability of the supplied machine is only guaranteed in case of intended use in accordance to chapter 2 - General - of the operating manual.

The limit values stated in the data sheet must not be exceeded in any way.

## 4. Transport, storage and disposal

### 4.1 Transport



- When choosing lifting tools and separate lifting accessories the weight of the pump must be taken into consideration. The corresponding accident prevention regulations have to be observed.

(In Germany: UVV "Lastaufnahmeeinrichtungen im Hebezeugbetrieb", BG 9a)

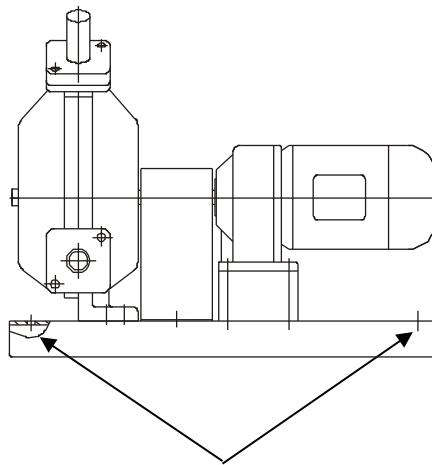

**Holes for lifting the pump**  
(resp. to fix the base plate of stationary pumps)

### 4.2 Storage

The pump has to be protected against humidity when stored

#### CAUTION

In case of longer standstill before placing the pump into operation do not assemble the pump hose, during longer shutdown periods remove the hose from the pump. Otherwise the hose could be warped by the constant compression of the rollers!

### 4.3 Disposal



With prolonged use, pump parts can get contaminated by poisonous or radioactive pumped liquids to such an extent that cleaning may be insufficient.

#### CAUTION

Risk of poisoning and environmental damage by the pumped liquid!

- Use suitable personal protective equipment when carrying out any work on the pump.
- Prior to disposal of the pump:

- Remove and dispose grease in accordance with local regulations.
  - Dispose any leaking pumped liquid in accordance with local regulations.
  - Neutralize residues of pumped liquid in the pump.
- Dispose of the pump unit and associated parts in accordance with statutory regulations.

## 5. Description of pump and accessories

The pump head is connected with the drive by a coupling. Pump head and drive are completely mounted on a base plate. Construction "0" means that the pump head is supplied with bare shaft extension.

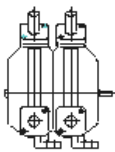
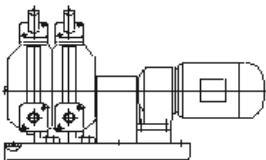
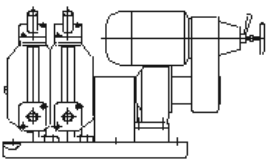
	Construction	Description
	- <b>XXX</b>	- pump head with bare shaft extension, without drive
	- <b>GMC</b> - <b>GMC-TF</b> - <b>GMC-FF</b> - <b>GMC-I1/I3</b> - <b>GMC-V1/V3</b>	- pump with gear motor - pump with gear motor incl. thermistors for frequency converter use - pump with gear motor incl. thermistors and forced fan - pump with gear motor with integr. frequency converter - pump with gear motor with integr. frequency converter and forced fan
	- <b>BDC</b>	- pump with variable speed drive

	P_classic 10 twin / PC_10-T	P_classic 15 twin / PC_15-T	P_classic 27 twin / PC_27-T	P_classic 35 twin / PC_35-T	P_classic 50 twin / PC_50-T
Material of pump housing:	Aluminium alloy				
Material of base plate:	Steel (standard)				
Paint of the pump:	RAL 5003 (standard)				
Diameter of shaft (mm):	10 <sub>k6</sub>	15 <sub>k6</sub>	20 <sup>(-0,02)</sup> <sub>(-0,05)</sub>	25 <sup>(-0,02)</sup> <sub>(-0,05)</sub>	30 <sup>(0)</sup> <sub>(-0,02)</sub>

## 5.1 Detector for hose leakages

The hose leakage detector is for a continuous monitoring in order to avoid unnoticed hose leakages.

### Functional description

In case of a hose leakage the pump can be switched off and an alarm (horn/signal lamp) can be activated. This is only possible when using a motor contactor. A proper function is only guaranteed when pumping conductive media.

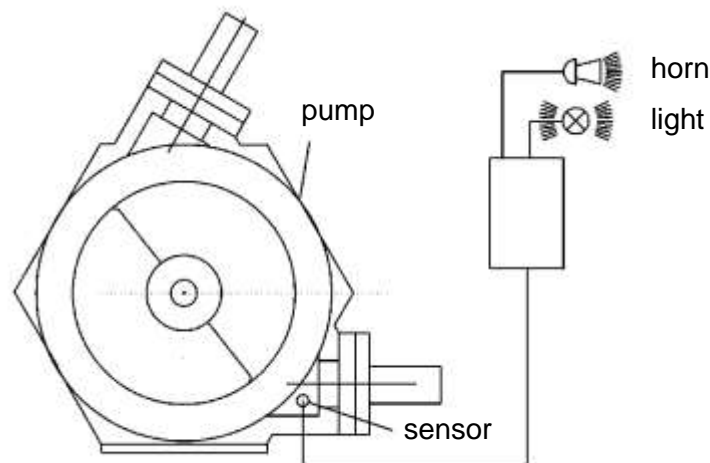

**The following mentioned detectors for hose leakages are available:**

Part no. 93-000-058

Detector for hose leakages for operating the pumps in non-hazardous locations and for electrically conductive media.

Part no. 93-000-045

Detector for hose leakages with PLC sensor for operating the pumps in non-hazardous locations and for electrically conductive and non-conductive media.

Part no. 93-000-006

Detector for hose leakages for operating the pumps in hazardous locations and for electrically conductive and non-conductive media.

**CAUTION**

If other sensors are used, the operator is responsible for checking their suitability.

## 5.2 Diagram of the leakage detector for operating the pumps in non-hazardous locations (Part no. 93-000-003)

The following diagram is only valid for the leakage detector consisting of:

- 2 sensors for leakage detector (make Ponndorf, standard)
- switch amplifier (make: Disibeint, type DNSA)

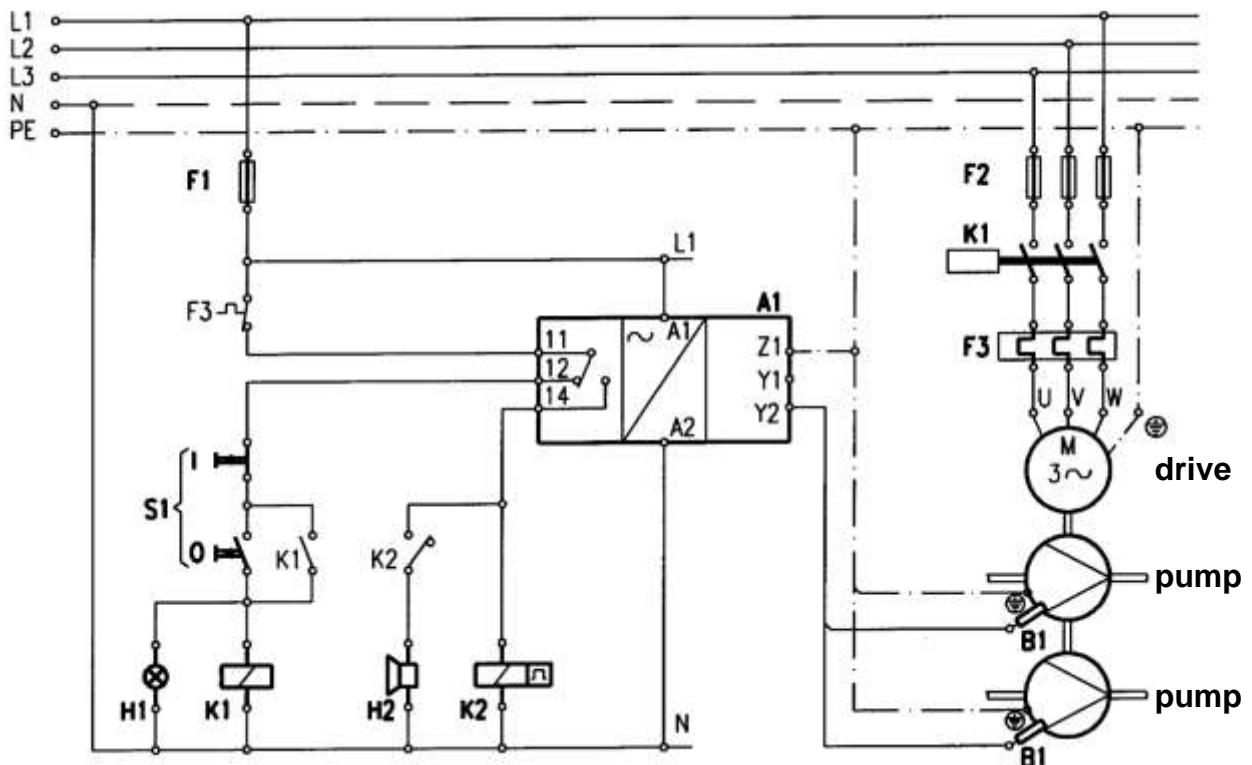

A1 - level control, type DNSA

B1 - sensor

F1 - fuse

F2 - motor fuse

F3 - motor overloads

H1 - run light

H2 - signal horn, signal lamp

K1 - motor contactor

K2 - flasher (0,5 sec.)

M - motor (pump drive)

S1 - push button



**The connections must only be made by qualified and authorized personnel!**



**This sensor is prohibited for use in hazardous locations. For such operating conditions a special leakage detector is available.**



### 5.3 Diagram of the leakage detector for operating the pumps in hazardous locations (Part no.93-000-006)

The following diagram is only valid for the leakage detector consisting of:

- capacitive proximity switch (make: Rechner)
- switch amplifier (make: Rechner)



The switch amplifier must not be used in hazardous locations. It has to be strictly installed outside of these areas.

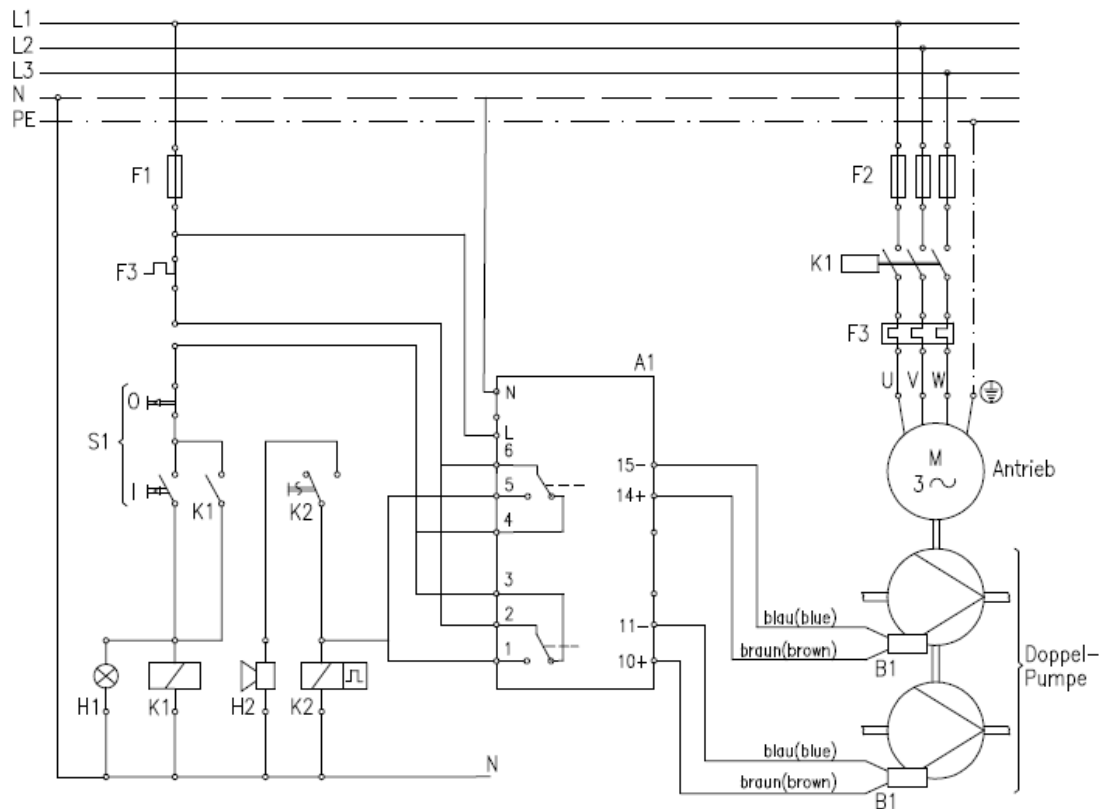

A1 – switch amplifier Typ N-132/2-01  
B1 – capacitive sensor (2-wire NAMUR)  
F1 – control fuse  
F2 – motor fuse  
F3 – motor protection relays  
H1 – control lamp-operation

H2 – signal horn, signal lamp  
K1 – motor contactor  
K2 – flasher relays 0,5 sec.  
M – motor – pump drive  
S 1 – double push button



**The connections must only be made by qualified and authorized personnel!**

---

## 6. Installation / Connection / Operation

### Installation

The installation of the pump depends on the pump type and can be made stationary or movable (on wheels).

#### 6.1 Installation of pumps in hazardous locations



- When pumps have to be installed in hazardous locations the instructions in chapter 3.2 must be strictly observed.
- Ponndorf Hose Pumps of series P\_classic twin for hazardous location use (optional!) meet the construction requirements of equipment group II, category 3G/2G. They are intended for use in zone 1.
- Hose pumps for hazardous location use in construction “0” (see chapter 5 - Description of pump and accessories -)<sup>1)</sup>
  - are in accordance with temperature class T4.
  - are intended for use at an ambient temperature between +2°C and +40°C (permissible temperature of place of installation).
  - are suitable for pumping media with a maximum temperature of:
    - +60°C in continuous operation
    - +80°C in short-time operation (operating time max. 1 h)
  - fulfill the requirements for non-electrical devices of the type of protection c - protection through safe construction (marking with Ex h for non-electrical explosion protection) - according to EN 80079-36 and EN 80079-37.
- are allowed for the explosion group IIB.

<sup>1)</sup> **The explosion protection for complete aggregates can diverge!** The details of the enclosed declaration of conformity are relevant!

## 6.2 Electrical connection

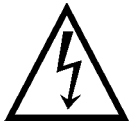

**The connections must only be made by qualified and authorized personnel!**

The connections must be made according to the wiring diagram in the terminal box.

**For instructions to effect the electrical connection please see the attached manual of the pump drive!**

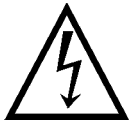

The pump must be protected by fuses and a protective motor switch according to the nominal current of the motor.



The pumps must be integrated in the equipotential bonding of the whole plant. For example this can be made by grounding the base frame by using the grounding terminal in the terminal box of the motor.

## 6.3 Mechanical connection

**The nominal width of the tubing at the suction and the discharge side should be approx. 25 % bigger than the nominal width of the pump hoses.**

**In case of connecting suction resp. discharge pipes please consider the instructions on page 17.**

The size of the hose pump is concurrent to the width of the pump hoses.

The tubing on the suction side must be vacuum proof (reinforced) and the tubing on the discharge side must withstand the maximum pressure of the pump. By using a pole changing switch the tubing on suction and discharge side must withstand the maximum pressure of the pump.

Always use flexible tubing to connect the pump with the pipework of your application. The length of the tubing should be at least 1 m. (see fig. 6.3.1).

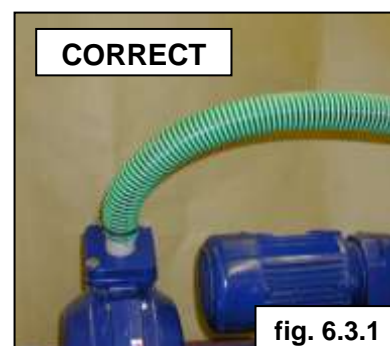

The standard way of connection is flexible tubing (fitting the connecting sockets of the pump), fixed with hose band clamps. Other options (e.g. threaded connections, Kamlok couplings, standard flanges) are available on request.

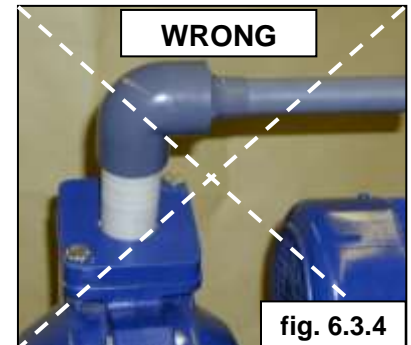
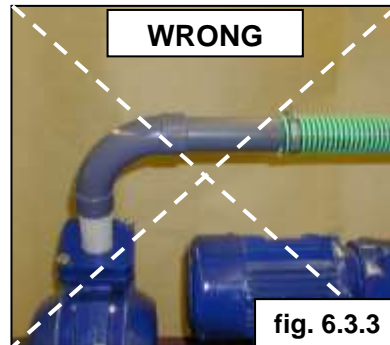
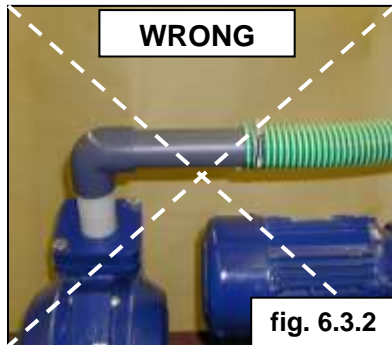

In order to avoid pressure peaks, which can cause damages of the pump hoses, there should no pipe bends or 90° elbows be installed directly after the pump on the discharge side (please see fig. 6.3.2 and 6.3.3).

Furthermore the cross section of the pipework on the discharge side should not be reduced (please see fig. 6.3.4).

In case of connecting of suction resp. discharge pipes please consider that the cross section of the continuative pipes are as large as necessary. The transition to the continuative pipe must be big enough. (see fig. 5.3.5).

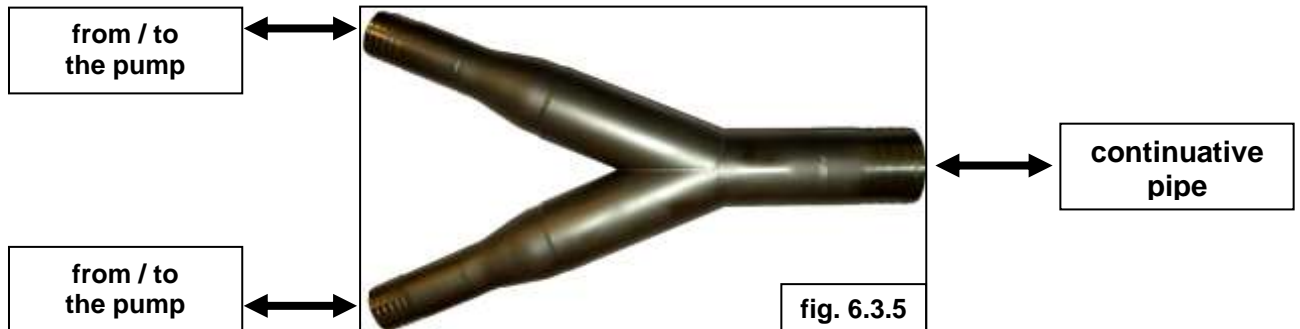

### **Important notice for the conveyance of media containing solids**

There is a risk of sedimentation of solids which can settle in the pump while the pump is stopped. Hereby a lump of solids can be formed in the upper section of the hose. If the upper connecting socket of the pump is the outlet (discharge side), the lump blocks the pump when it is restarted (please see pic. 6). This may cause damages to the pump.

To avoid any damages we recommend to reverse the direction of rotation of the pump and to connect the discharge line to the lower, horizontal connecting socket.

To get a further advantage a flexible hose should be used to connect the pump and a kind of trap should be created in which the solids settle out (please see pic. 7).

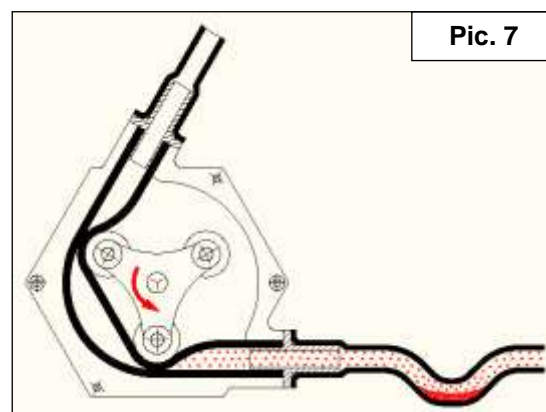
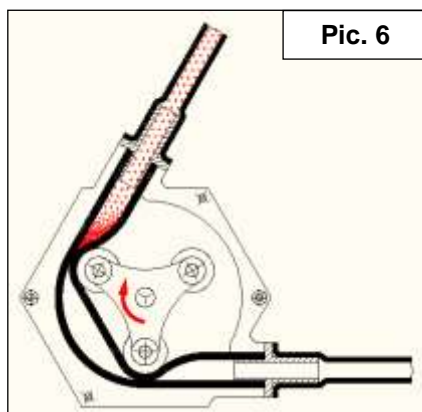

In case of longer downtimes it is also recommended to flush the complete piping including the pump sufficiently.



Hose pumps are positive displacement pumps which must not convey against closed fittings (e.g. valves). In case of exceeding the maximum permissible pressure, the pumps or other parts of the facility can be damaged. Therefore a protection against pressure exceedance must be integrated in the pipework on the discharge side (e.g. an overflow valve or a burst disk).



When using overflow valves or burst disks it must be observed that the overpressure always will be discharged in a safe direction. I.e., neither people nor tangible assets may be endangered because of emissions of the pumping medium.



If flammable liquids or gases may leak, the affected area of emission must be free of ignition sources!

#### 6.4 Installing the pump hoses

**CAUTION**

The outer surface of the pump hoses must be lubricated sufficiently with Ponndorf Special Grease before assembling them.



Remove power from the pump by removing the main fuses before doing any cleaning / maintenance / assembly operations.

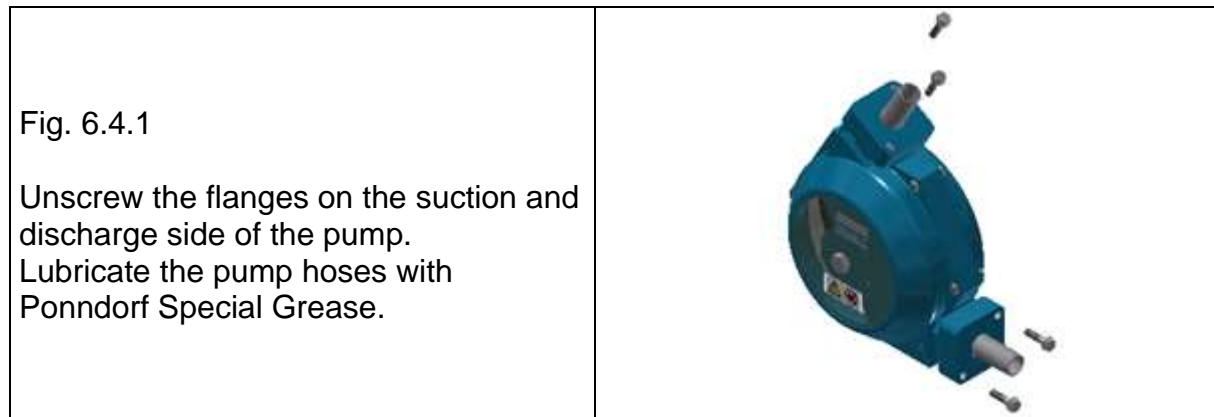

**Do not wear gloves during these operations because they may be pulled in!**

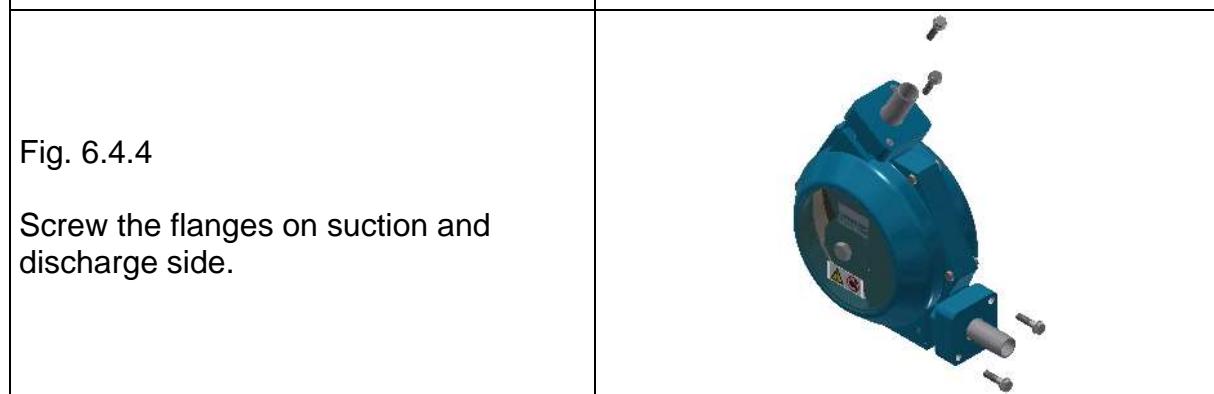
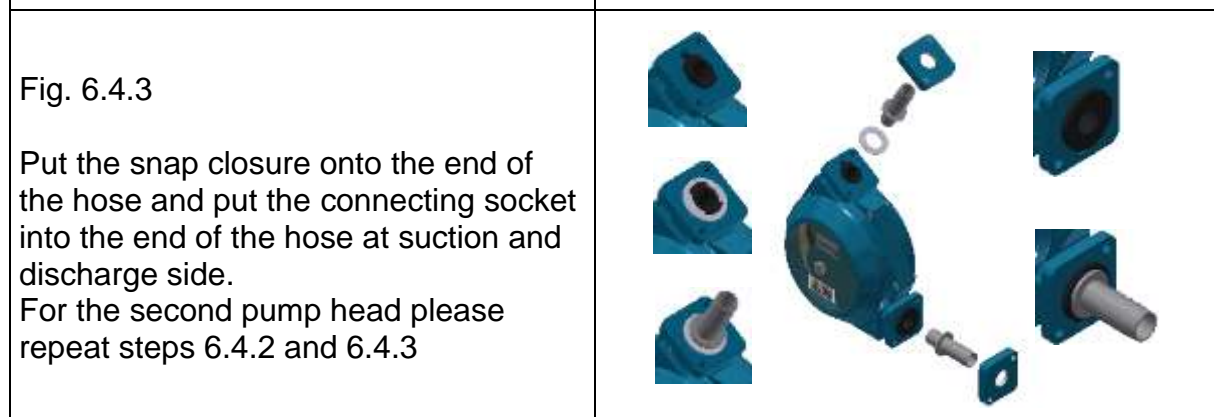
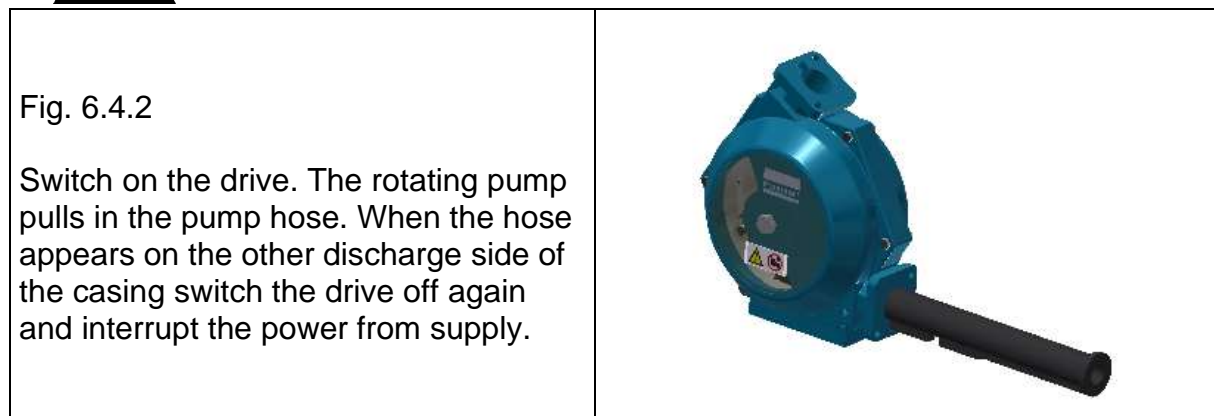

## **Pump is now ready for operation!**

**CAUTION**

Before starting the pump it must be secured that any valves assembled in the pipework (on suction and discharge side) are opened.

Otherwise the pump or parts of the pipework could be damaged by too high increase of pressure.



The casing cover may only be removed when the drive is switched off and the power supply is interrupted (remove fuses).

**CAUTION**

If the pump is equipped with a hose leakage monitor it must be ensured that the sensor is not soiled and, in particular, that the pump hose is not lubricated too much, as soiling and deposits on the sensor can impair its functionality.



## 7. Maintenance / Service



There are no sophisticated procedures of maintenance necessary for Ponndorf Hose Pumps.

Nevertheless there have to be made regular inspections in order to avoid any decrease of capabilities of the pump (e.g. suction capacity / discharge head / flow rate).

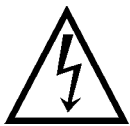
### 7.1 Changing the pump hose



Remove power from the pump by removing the main fuses before doing any cleaning / maintenance / assembly operations !

<p>Fig. 7.1.1</p> <p>Unscrew the flanges on suction and discharge side.</p>	
<p>Fig. 7.1.2</p> <p>Pull connecting sockets out of the end of the hose on suction and discharge side. Remove snap closure from the end of the hose.</p>	



**Do not wear gloves during these operations because they may be pulled in!**

<p>Fig. 7.1.3</p> <p>Pull out the defect hose/s. The extraction of the hose/s will be eased by changing the direction of the drive (pole changing switch) and starting of the motor.</p>	
--	---

For installation of the new pump hose/s please consider chapter 6.4



It must be secured that there are no remains of the pumping medium left in the pump hoses (medium could run out or spray). Especially in case of aggressive and caustic media there is danger of injuries!

## 7.2 Maintenance / Service

To guarantee a constant elasticity of the pump hose it must be lubricated with Ponndorf Special Grease every 300 hours of operation. To do this remove the casing cover and put some grease through the opening onto the running surface of the pump hose (e.g. by using a screw driver).

<b>Outer surface of the pump hoses</b>	<b>Rotor bearings</b>	<b>Teflon rollers</b>
<ul style="list-style-type: none"> <li>• check on the grease film (enough grease on the running surface of the hose?)</li> <li>• <u>Interval:</u> every 300 hours of operation</li> </ul>	<ul style="list-style-type: none"> <li>• check on proper seat of bearings (no radial play!)</li> <li>• check on unusual heat generation</li> <li>• check on unusual and noticeable bearing noises</li> <li>• <u>Interval:</u> every time when changing the pump hose respectively every 500 hours of operation</li> </ul>	<ul style="list-style-type: none"> <li>• check on proper seat (no seized, not worn out)</li> <li>• <u>Interval:</u> every 500 hours of operation</li> </ul>



If the rotor bearings / Teflon rollers show the wear characteristics mentioned above they need to be replaced.

## 7.3 Cleaning

After pumping media which tend to deposit, the pump hoses must be rinsed out when pumping is finished.

When changing the pump hose the inside of the pump casing should be cleaned properly.

#### 7.4 Drawing of spare parts P\_classic 10 twin / PC\_10-T

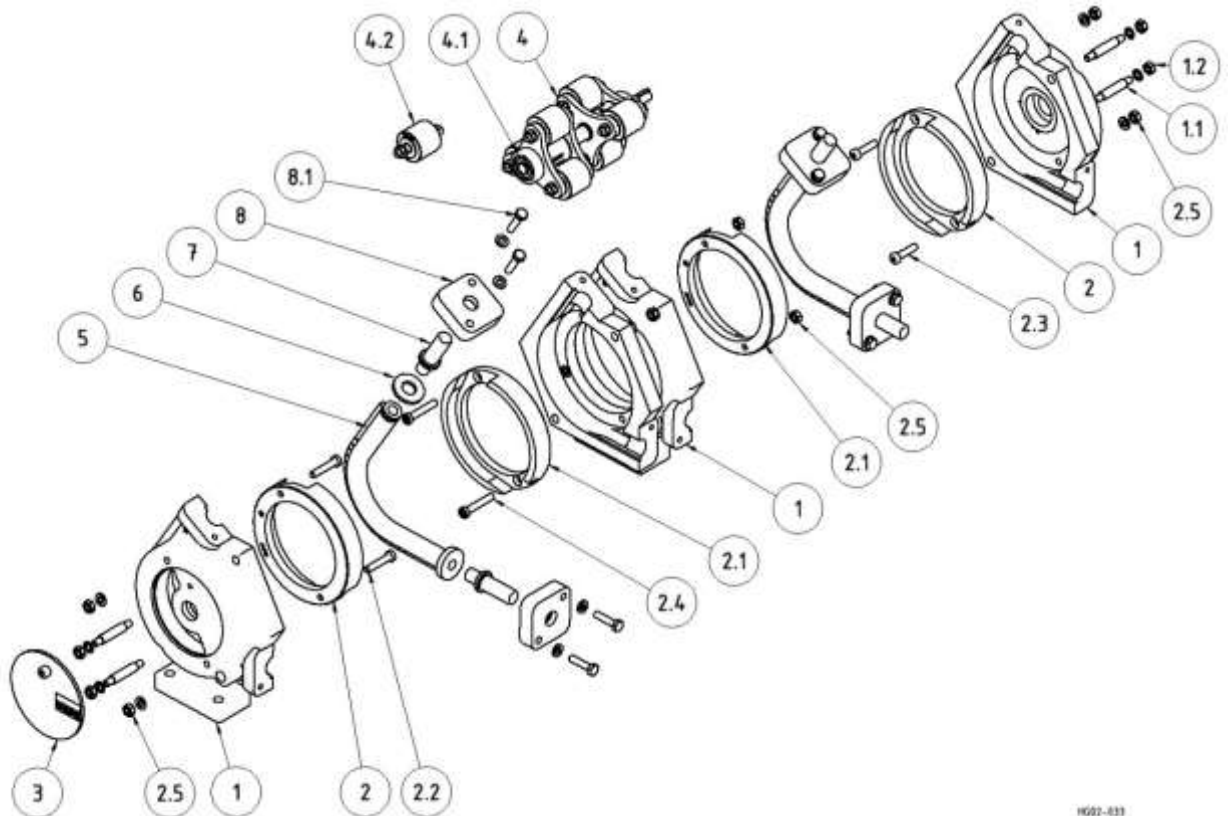

H002-633

## 7.5 List of spare parts P\_classic 10 twin / PC\_10-T

Pos.	Benennung		Anzahl/ Pumpe	Artikel-Nr.
1	Casing complete <sup>1)</sup>		1	11-010-010
2	Set of Inserts, Teflon <sup>1)</sup>	Set of 2 pieces		
	Material:	- standard	1	11-010-112
		- conductive (meets. ATEX)	1	11-010-112.Y
3	Casing cover complete <sup>1)</sup>			
	Material:	- plexiglass	1	10-010-007
		- 1.4301 / V2A (meets ATEX)	1	94-080-011
4	Rotor complete <sup>2)</sup>		1	11-010-022
4.1	Ball bearing		2	10-010-020
4.2	Rollers complete, Teflon	Set of 3 pieces	1	11-010-117
5	Pump hose			
	Material:	- natural rubber	2	10-010-060
		- natural rubber accord. FDA	2	10-010-066
		- neoprene	2	10-010-062
6	Snap closure		2	10-010-026
7	Connecting sockets			
	Material:	- polypropylene	4	10-010-027
		- 1.4571 / V4A (meets ATEX)	4	10-010-029
	Further connecting options			on request
8	Counter flange complete <sup>1)</sup>		4	10-010-025

<sup>1)</sup> incl. mouting material

<sup>2)</sup> incl. rollers and ball bearing



In case of operation of Ponndorf Hose pumps in hazardous locations (according to ATEX) the operator must make sure that only casing cover made of stainless steel (Pos. 3), inserts complete Teflon made of conductive material (Pos.2), and connecting sockets made of stainless steel (Pos. 7) will be used. Parts made of plexiglass, Teflon standard respectively PP (polypropylene) are not approved for this purpose!

7.6 Drawing of spare parts P\_classic 15-50 twin / PC\_15-T to PC\_50-T

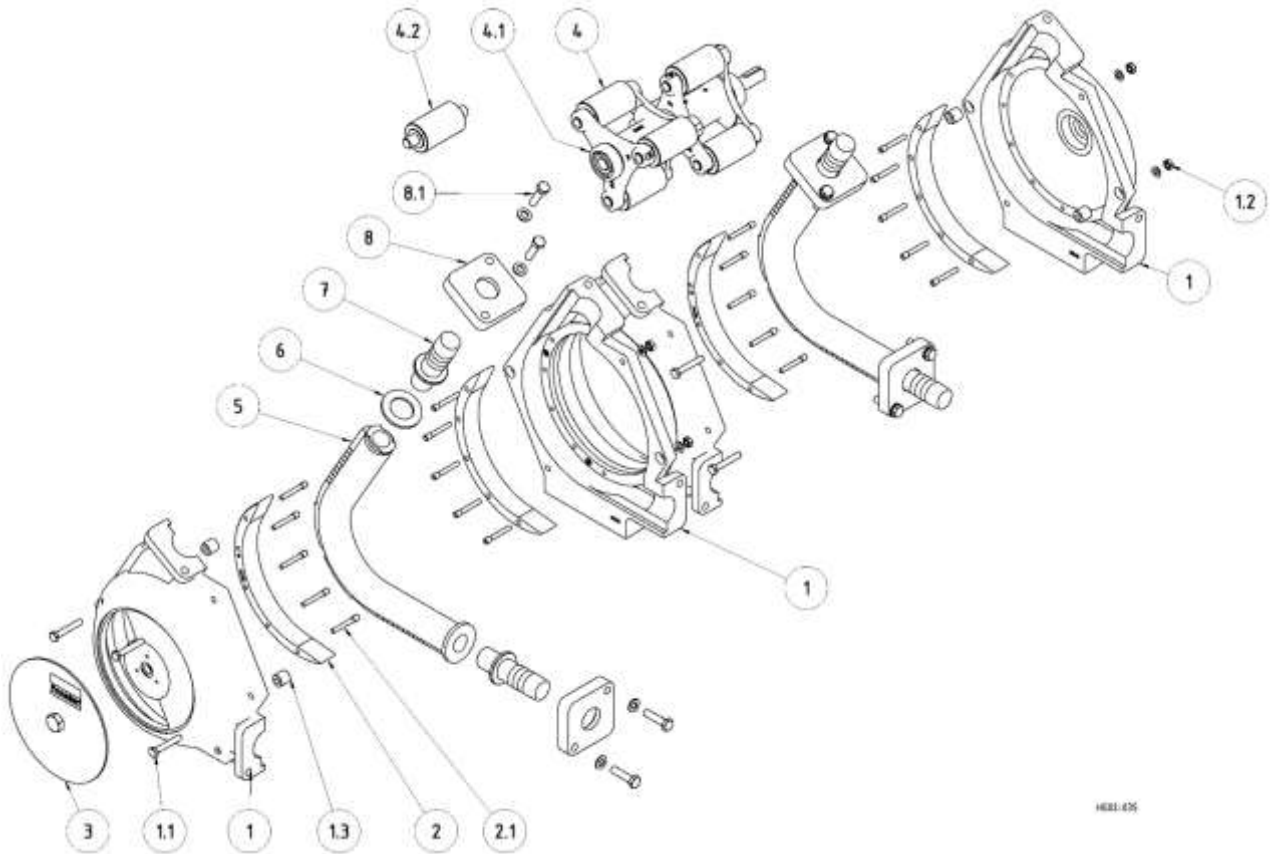

HEB 425

## 7.7 List of spare parts P\_classic 15-50 twin / PC\_15-T to PC\_50-T

Pos.	Benennung	Anz./ Pumpe	Artikel-Nr. / Baugröße				
			15	27	35	50	
1	Casing complete <sup>1)</sup>	1	11-015-010	11-027-010	11-035-010	11-050-010	
2	Set of Inserts, Teflon <sup>1)</sup>	Set of 2 pieces					
	Material:	- standard	1	11-015-112	11-027-112	11-035-112	11-050-112
		- conductive (meets. ATEX)	1	11-015-112.Y	11-027-112.Y	11-035-112.Y	11-050-112.Y
3	Casing cover complete <sup>1)</sup>						
	Material:	- plexiglass	1	10-015-007	10-027-007	10-035-007	10-050-007
		- 1.4301 / V2A (meets ATEX)	1	94-080-016	94-080-028	94-080-036	94-080-051
4	Rotor complete <sup>2)</sup>	1	11-015-022	11-027-022	11-035-022	11-050-022	
4.1	Ball bearing	2	10-015-020	10-027-020	10-035-020	10-050-020	
4.2	Rollers complete, Teflon	Set of 3 pieces	1	11-015-117	11-027-117	11-035-117	11-050-117
5	Pump hose						
	Material:	- natural rubber	2	10-015-060	10-027-060	10-035-060	10-050-060
		- natural rubber accord. FDA	2	10-015-066	10-027-066	10-035-066	10-050-066
		- neoprene	2	10-015-062	10-027-062	10-035-062	10-050-062
6	Snap closure	2	10-015-026	10-027-026	10-035-026	10-050-026	
7	Connecting sockets						
	Material:	- polypropylene	4	10-015-027	10-027-027	10-035-027	10-050-027
		- 1.4571 / V4A (meets ATEX)	4	10-015-029	10-027-029	10-035-029	10-050-029
	Further connecting options		auf Anfrage				
8	Counter flange complete <sup>1)</sup>	4	10-015-025	10-027-025	10-035-025	10-050-025	

<sup>1)</sup> incl. mouting material

<sup>2)</sup> incl. rollers and ball bearing



In case of operation of Ponndorf Hose pumps in hazardous locations (according to ATEX) the operator must make sure that only casing cover made of stainless steel (Pos. 3), inserts complete Teflon made of conductive material (Pos.2), and connecting sockets made of stainless steel (Pos. 7) will be used. Parts made of plexiglass, Teflon standard respectively PP (polypropylene) are not approved for this purpose!

## 8. Characteristic curves

P\_classic 10 twin / PC\_10-T

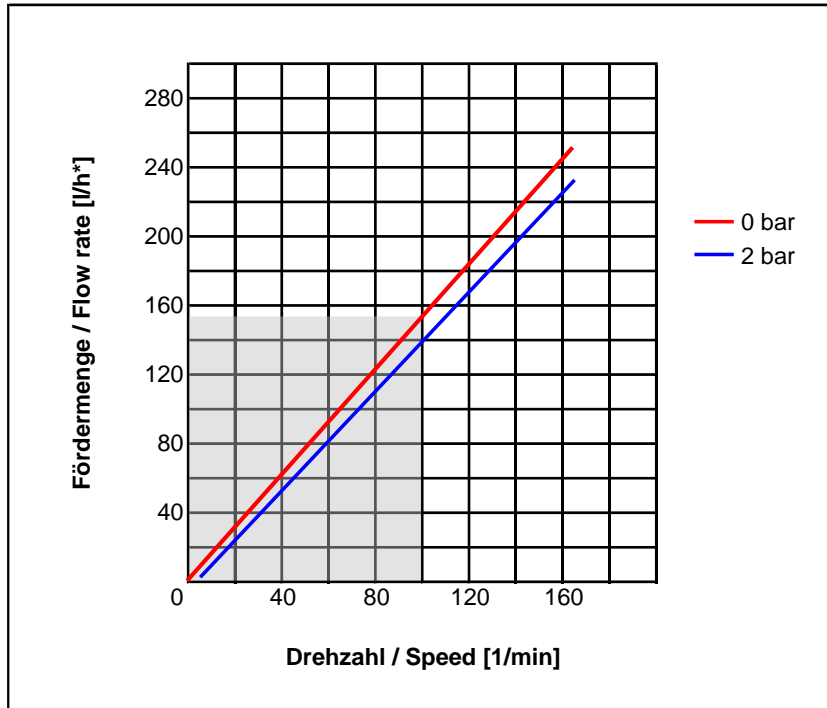

P\_classic 15 twin / PC\_15-T

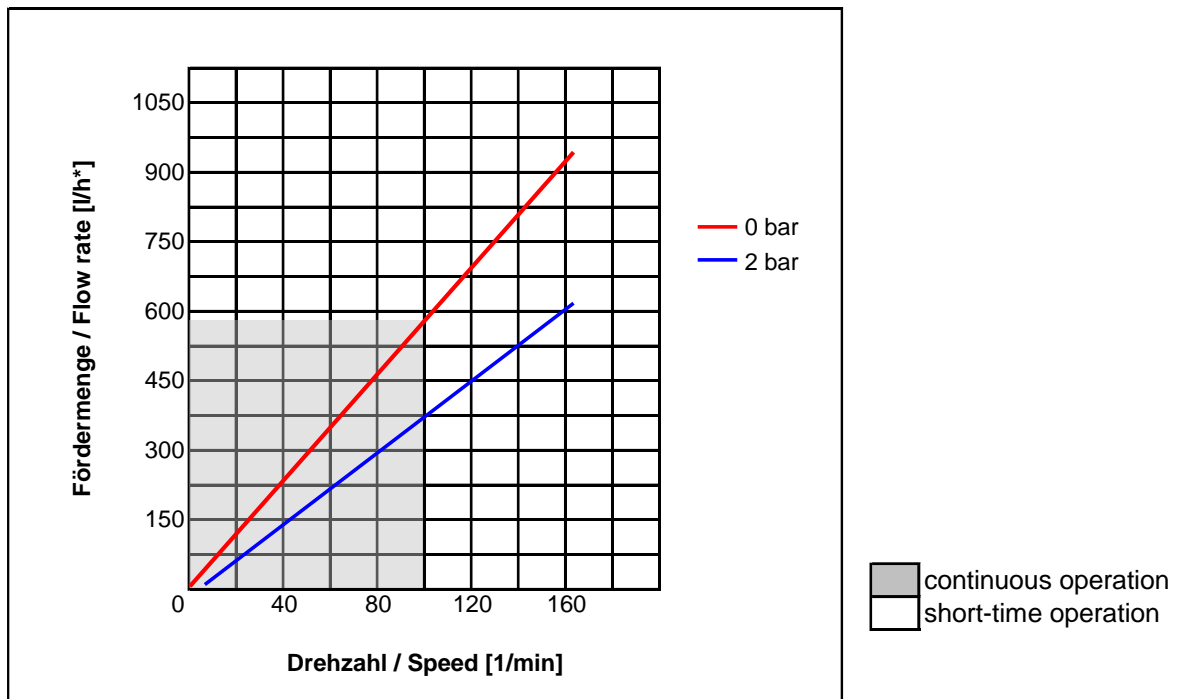

**P\_classic 27 twin / PC\_27-T**

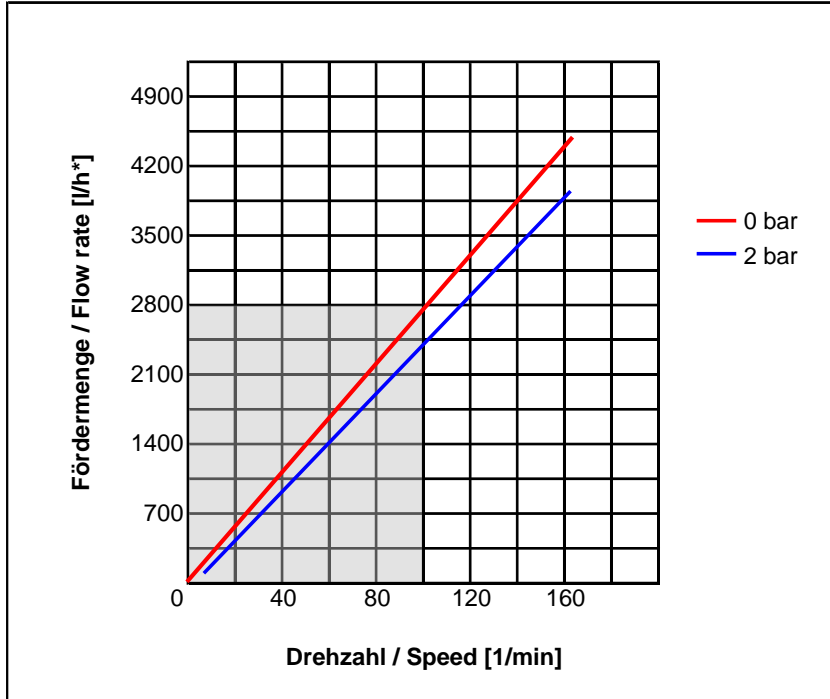

**P\_classic 35 twin / PC\_35-T**

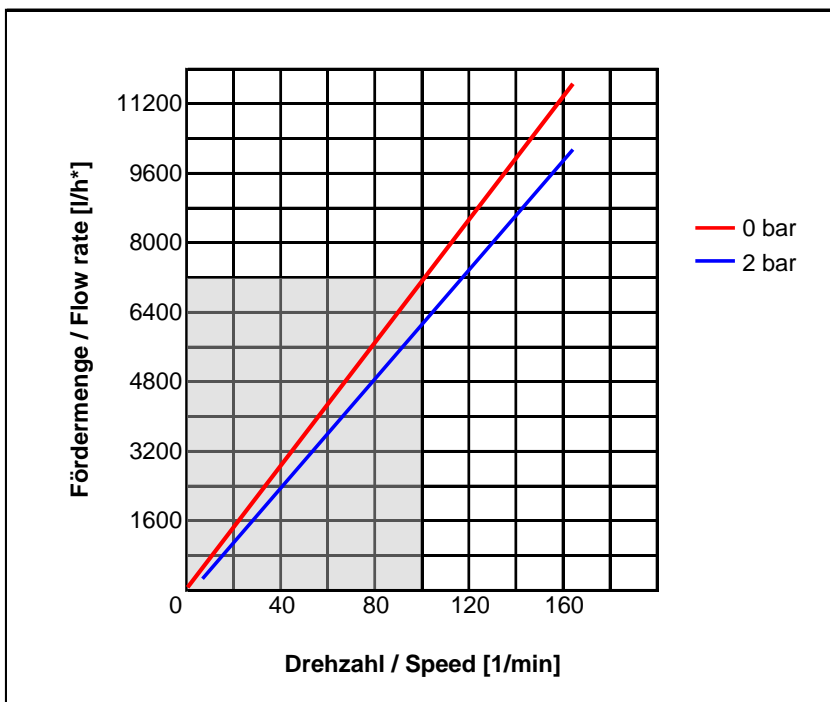



**P\_classic 50 twin / PC\_50-T**

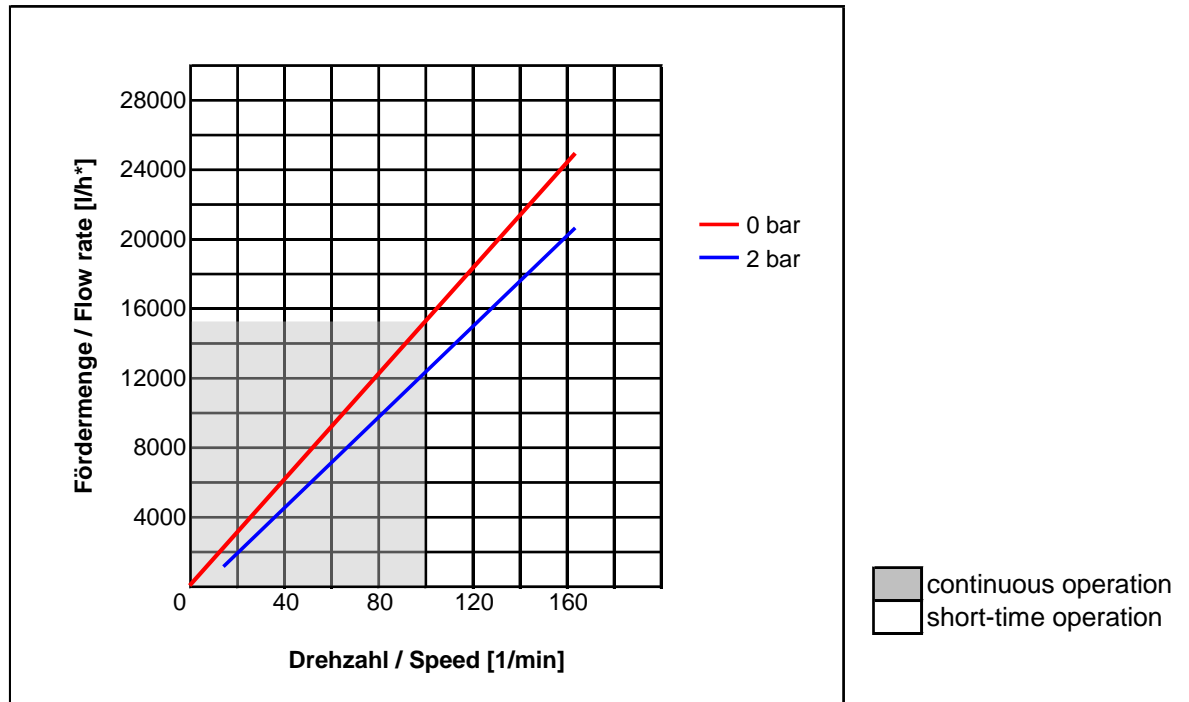

**Important:**

The characteristic curves are based on pumping water.  
So the actual flow rate of the pump can be different in case of pumping media with a higher viscosity.

**9. Accompanying documents**

Accompanying documents are enclosed (corresponding to the extent of delivery).

## EU – DECLARATION of CONFORMITY

Herewith we declare that the products

Designation: **PONNDORF hose pump units of the type**

**P\_classic (PC-S); P\_classic twin (PC-T)  
P\_classicplus (PCP-S); P\_classicplus twin (PCP-T)  
P\_food&pharma (PFP-S); P\_food&pharma twin (PFP-T)  
P\_eco  
P\_eco/food&pharma  
P\_high pressure (PHP-S); P\_high pressure twin (PHP-T)  
P\_delta (PD-S)  
P\_change (PCH-S)**

comply in the constructions delivered with the following EC / EU directives

- |            |   |
|------------|---|
| 2006/42/EC | Directive of the European Parliament and of the Council on machinery and amending Directive 95/16/EC  |
| 2014/35/EU | Directive of the European Parliament and of the Council on the harmonisation of the laws of the Member States relating to the making available on the market of electrical equipment designed for use within certain voltage limits |
| 2014/30/EU | Directive of the European Parliament and of the Council on the harmonisation of the laws of the Member States relating to electromagnetic compatibility   |

Applied, harmonized standards, in particular: - EN 809 A1/AC

Authorized representative for the completion of the technical documentation :

Till Völker  
Ponndorf Gerätetechnik GmbH  
Leipziger Straße 374, D – 34123 Kassel

Kassel, March 12, 2021  
(Place and date of issue)

  
.....  
Till Völker  
General Manager

This declaration is no warrant of properties for the purpose of the product liability. The safety instructions of the operating manual provided must be observed!  
If the above mentioned series are technically modified without our approval, this declaration shall no longer be applicable.

## EC – DECLARATION of CONFORMITY

Herewith we declare that the products

Designation: **PONNDORF hose humps of the types**

**P\_classic (PC-S); P\_classic twin (PC-T)  
P\_classicplus (PCP-S); P\_classicplus twin (PCP-T)  
P\_food&pharma (PFP-S); P\_food&pharma twin (PFP-T)  
P\_eco  
P\_eco/food&pharma  
P\_high pressure (PHP-S); P\_high pressure twin (PHP-T)  
P\_delta (PD-S)  
P\_change (PCH-S)**

complies with the following EC directives

2006/42/EC Directive of European Parliament and of the Council on machinery and amending Directive 95/16/EC

Applied harmonized standards, in particular: - EN 809 A1/AC

Authorized representative for the completion of the technical documentation :

Till Völker  
Ponndorf Gerätetechnik GmbH  
Leipziger Straße 374, D – 34123 Kassel

Kassel, March 12, 2021  
(Place and date of issue)

  
.....  
Till Völker  
General Manager

This declaration is no warrant of properties for the purpose of the product liability. The safety instructions of the operating manual provided must be observed!  
If the above mentioned series are technically modified without our approval, this declaration shall no longer be applicable.